

POLAR SCIENCE AND ENGINEERING...



A Model for NGSS Practices



US Ice Drilling Program



Strategic Planning for Science and Drilling Technologies

Today's Focus: The "Practices"

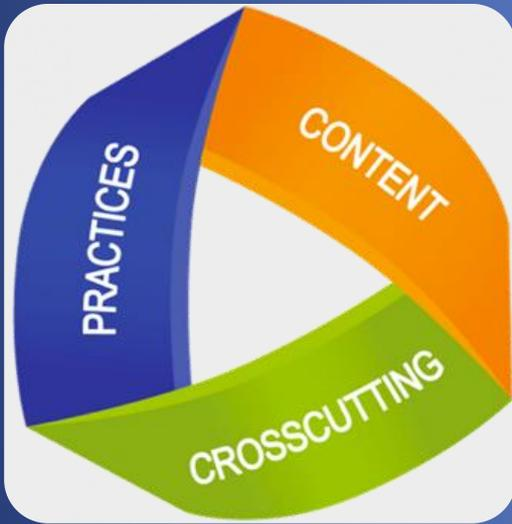

Processes of building and using Core Ideas to make sense of the natural and designed world.

Key Messages

- **Integration of engineering concepts and processes**
- **Parallel practices; different outcomes**
- **Emphasis on how scientists and engineers work together and communicate results**

Our Question:

**How can we as educators
effectively help students to
distinguish these practices?**

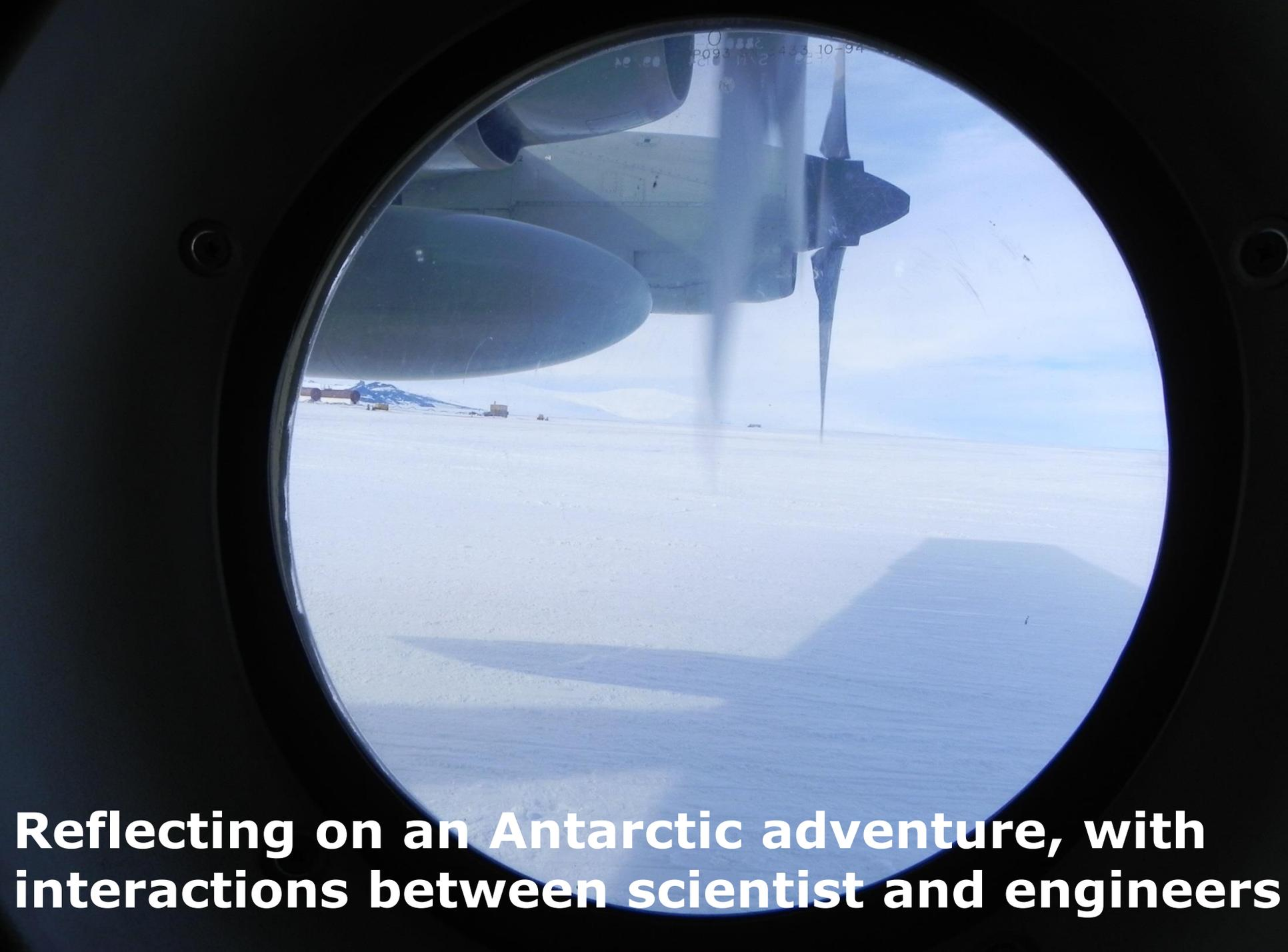

Reflecting on an Antarctic adventure, with interactions between scientist and engineers

**A key question being asked
by scientists is,**

**“How can we predict future
climate changes, and their impacts,
to empower decisions today ”**



What we know:

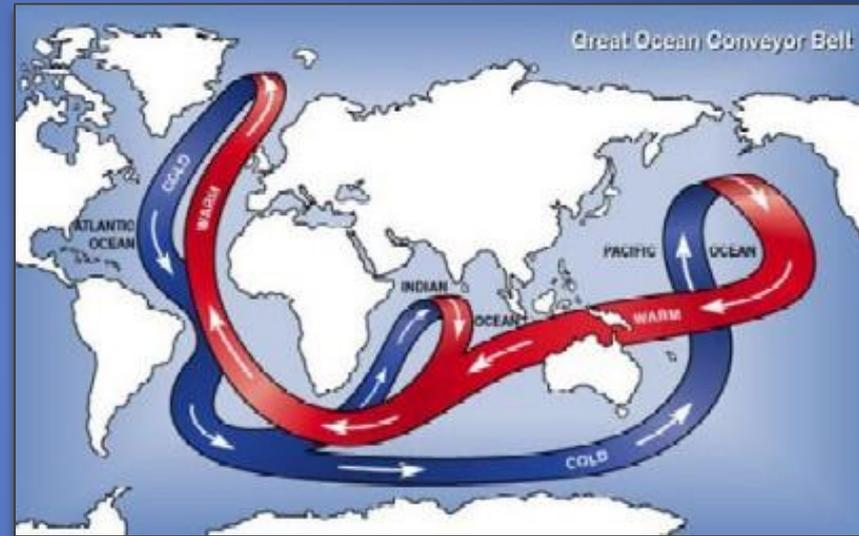
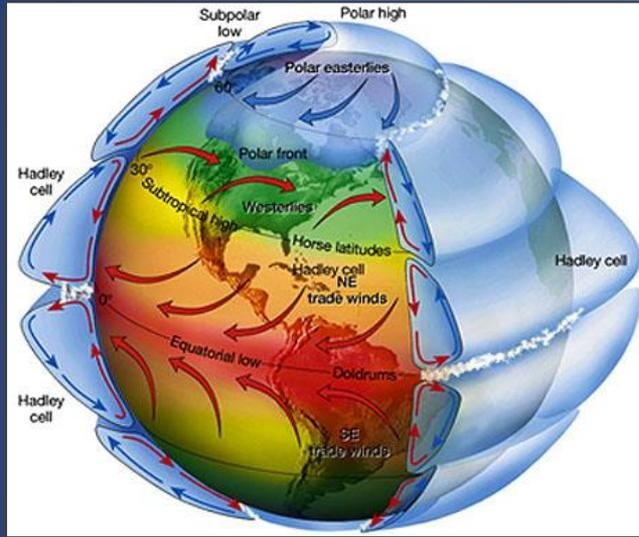

Earth's system of interacting systems influences long-term climate patterns

What we need to know: data from the past.

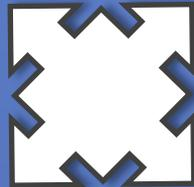
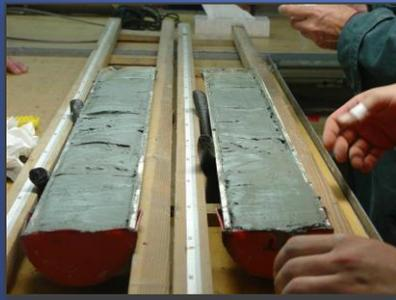
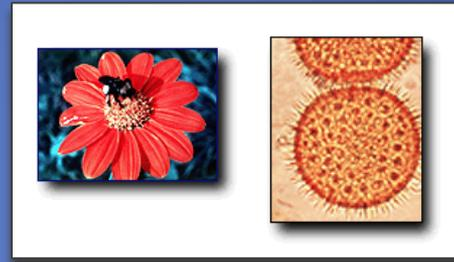

**We started by looking at strategies
others have used...**

Sediment core record showing glacial cycles

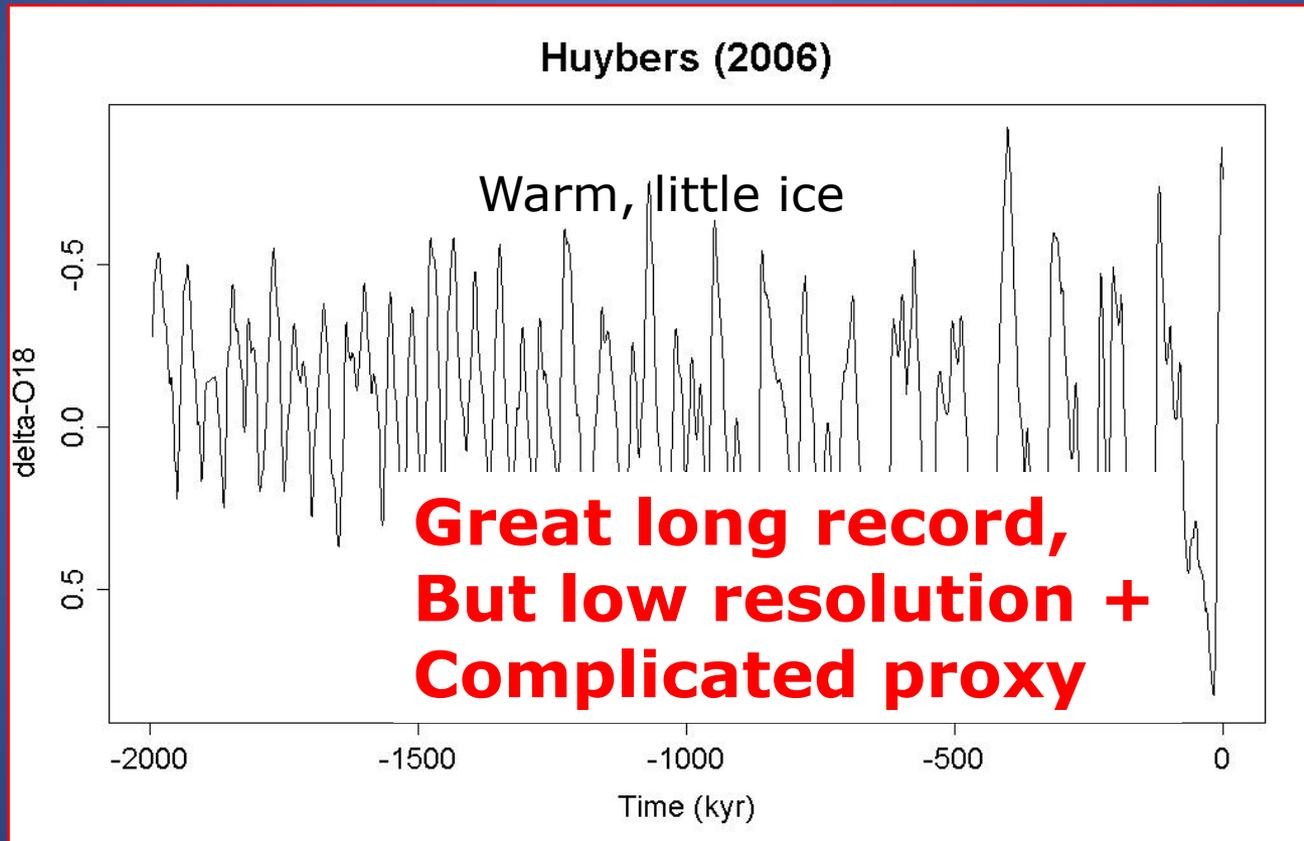

2 million
years ago

cold, lots of ice

Today

The moving atmosphere carries environmental evidence to the polar ice sheets

north

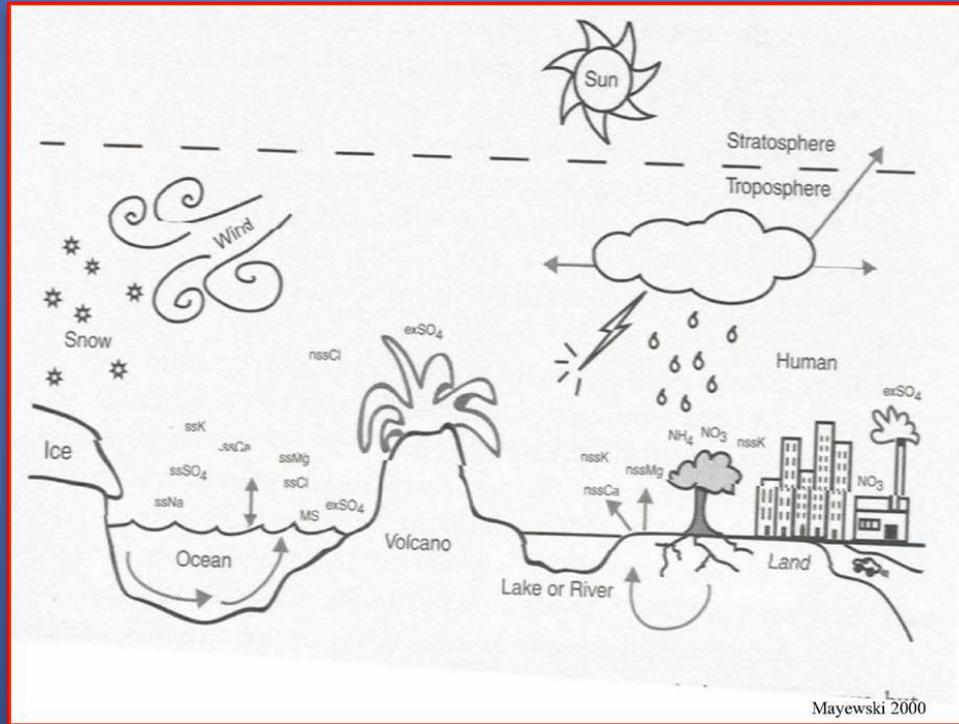

south

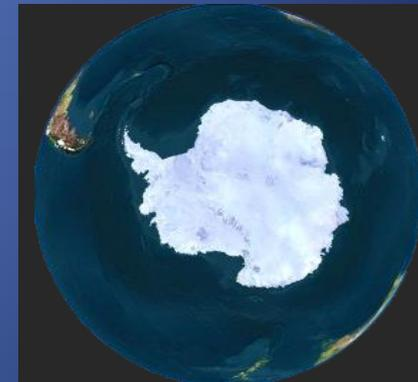

The evidence becomes archived in ice sheets

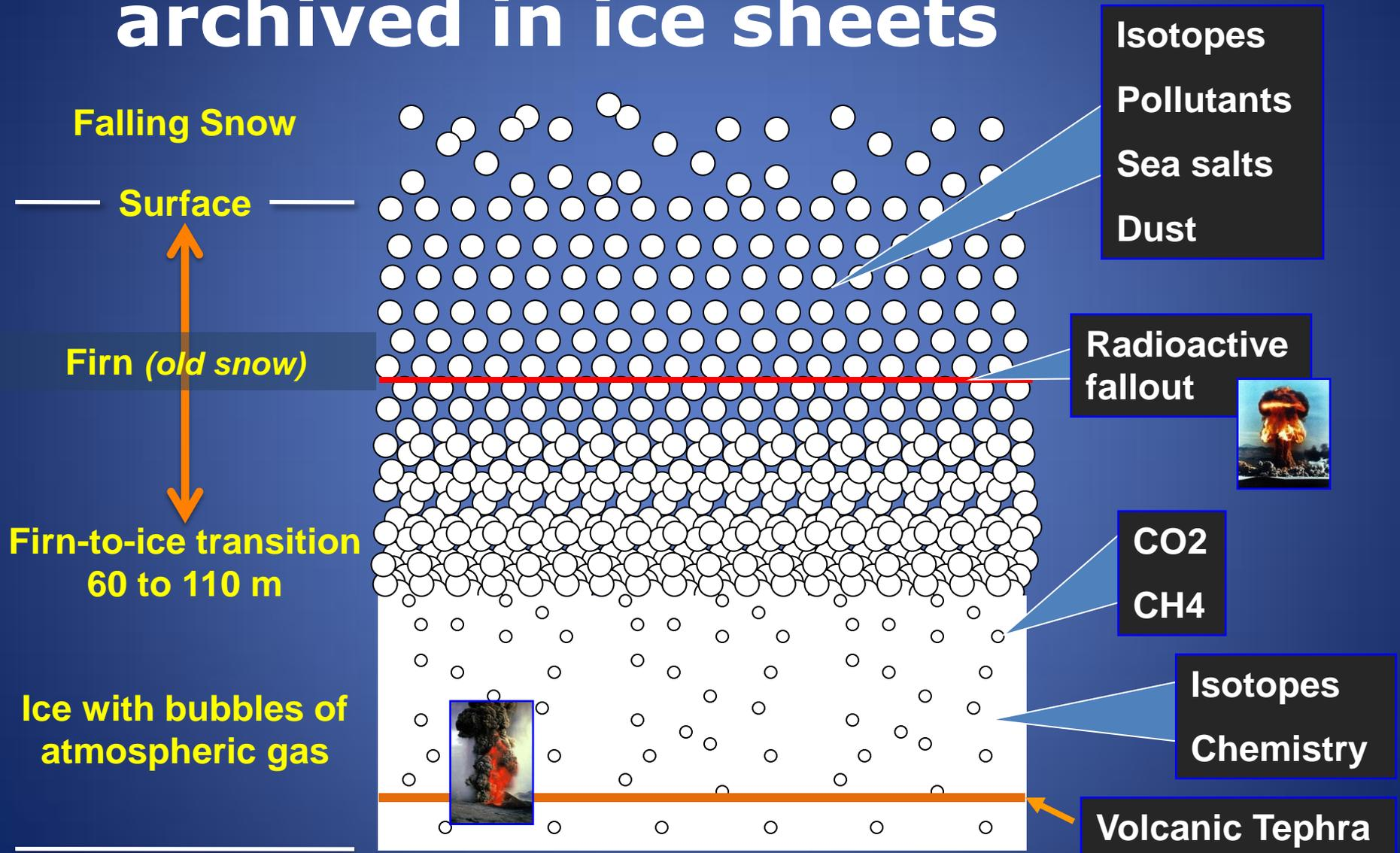

High accumulation layers yield high resolution ice core data at WAIS Divide, Antarctica

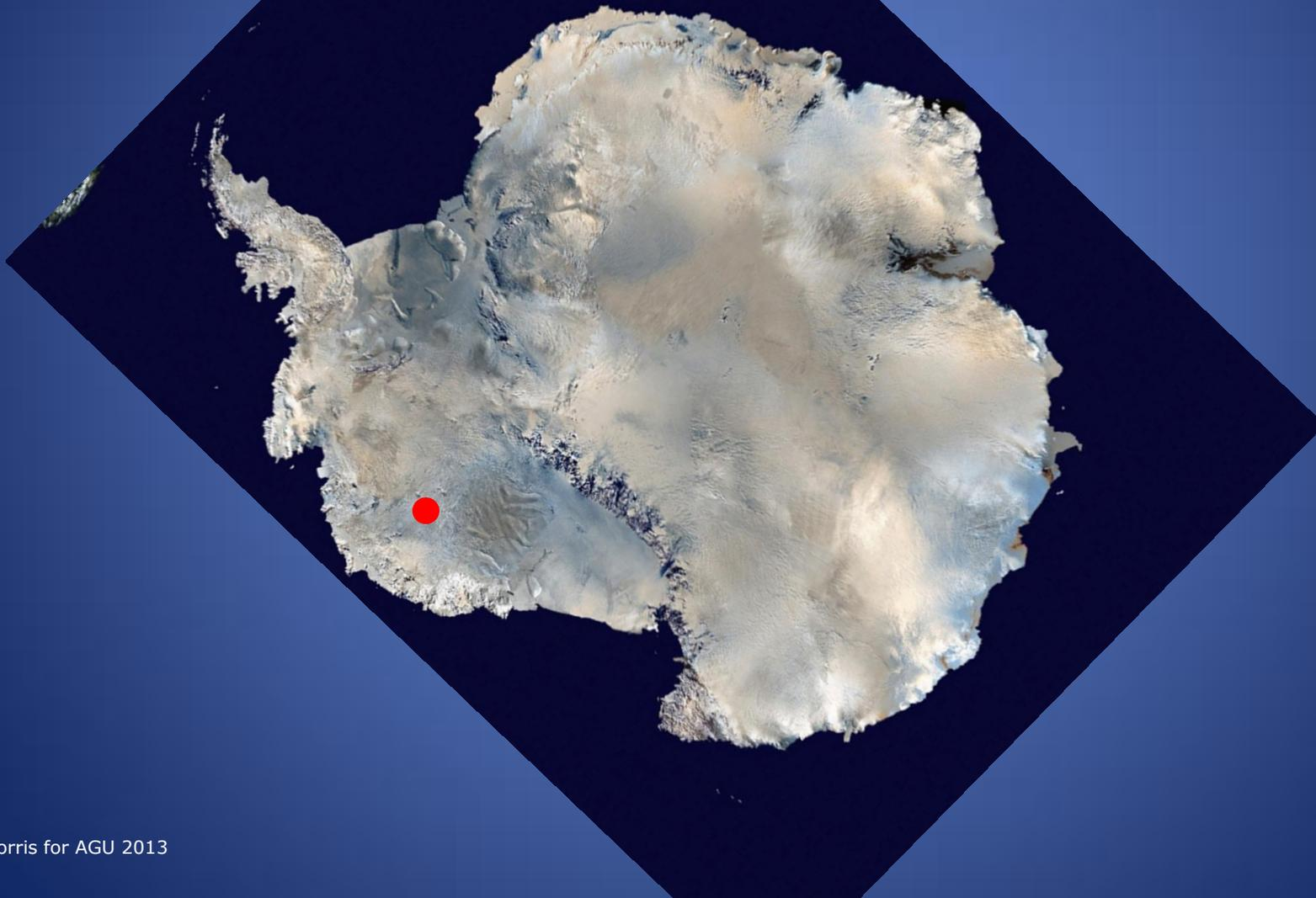

Drilled to 3400 m deep (more than two miles)



Recent Core From WAIS



Precisely Dated

Annual resolution to 30,000 years

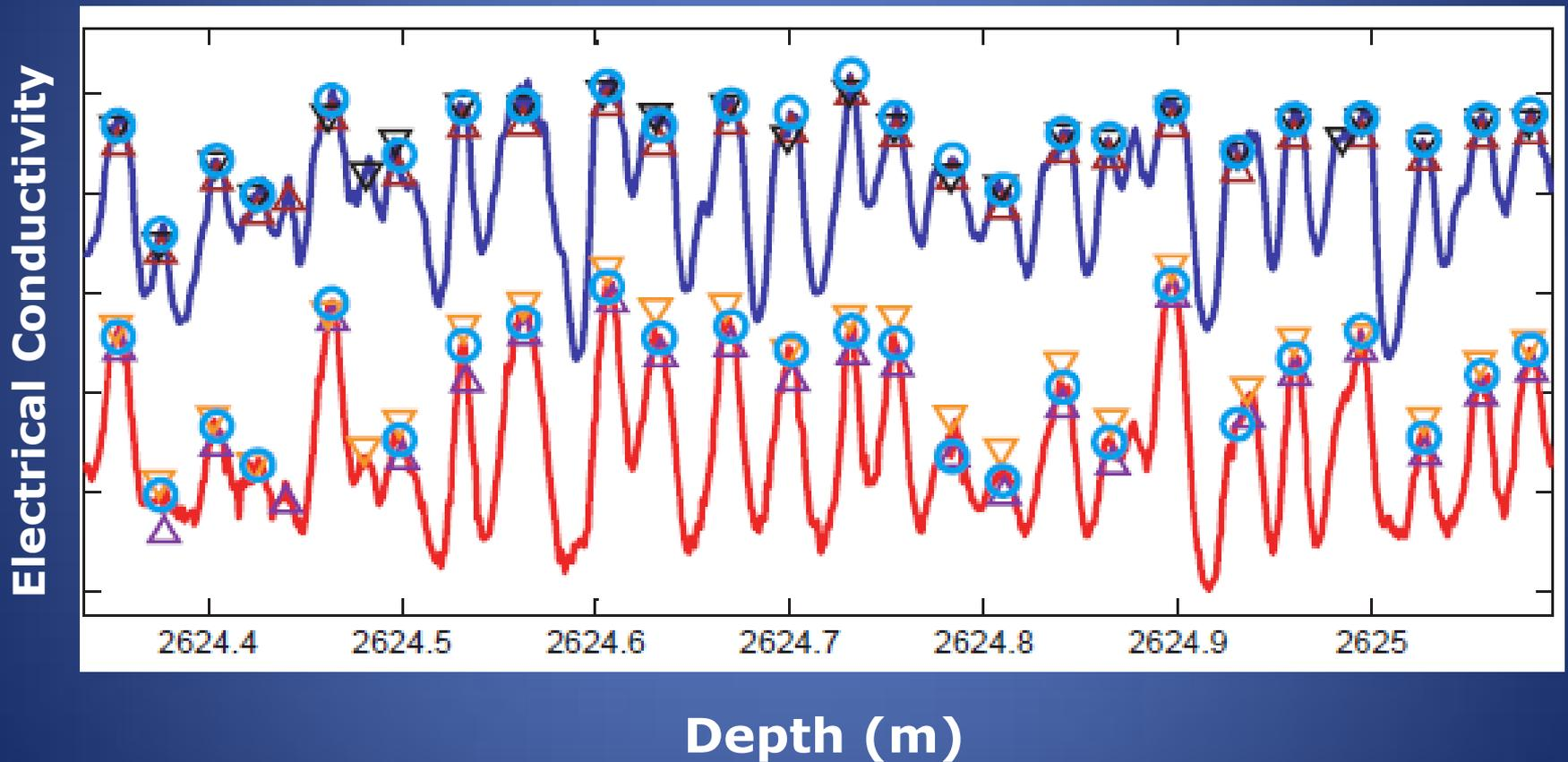

CO₂ and temp, rising together 18 K yrs ago

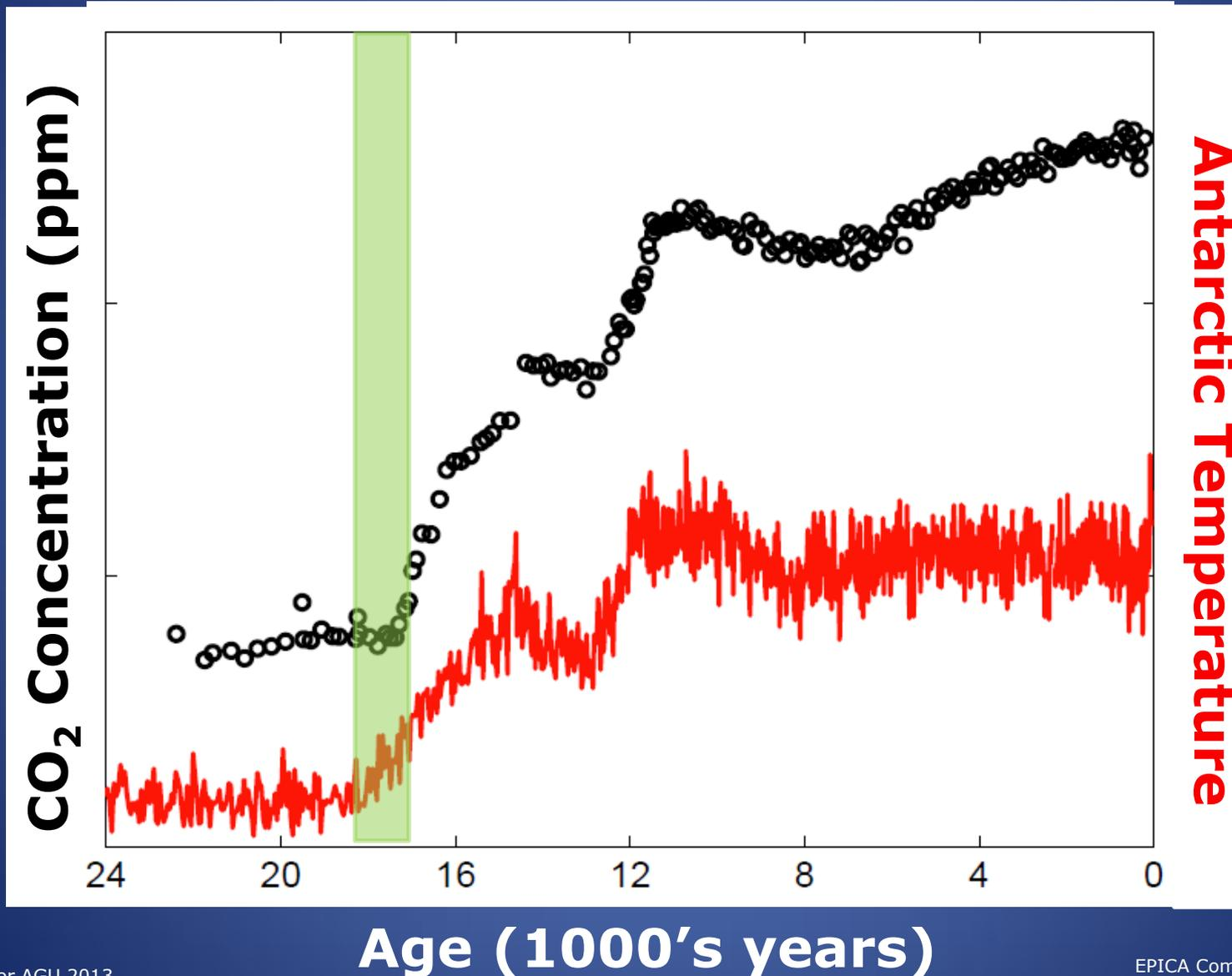

Scientist: A really interesting period- I need more ice!

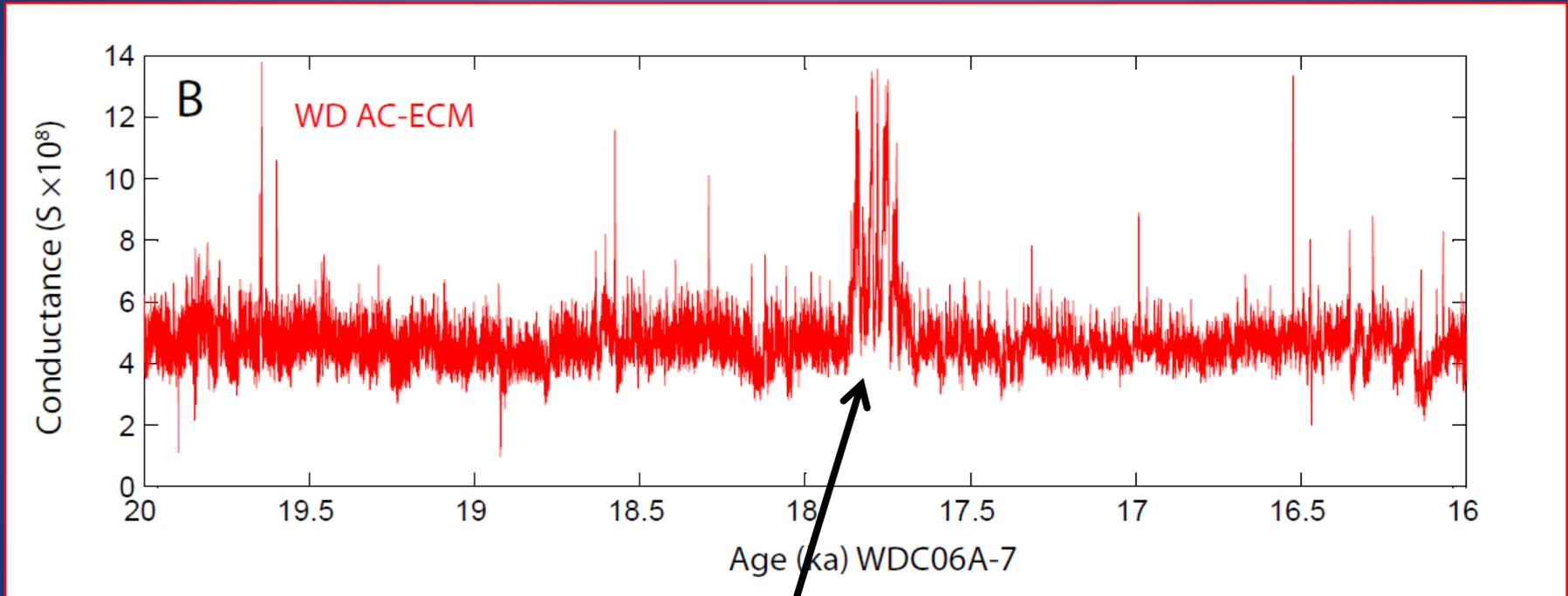

More ice core data is needed from this really funky event

Scientist: Can we drill another core?

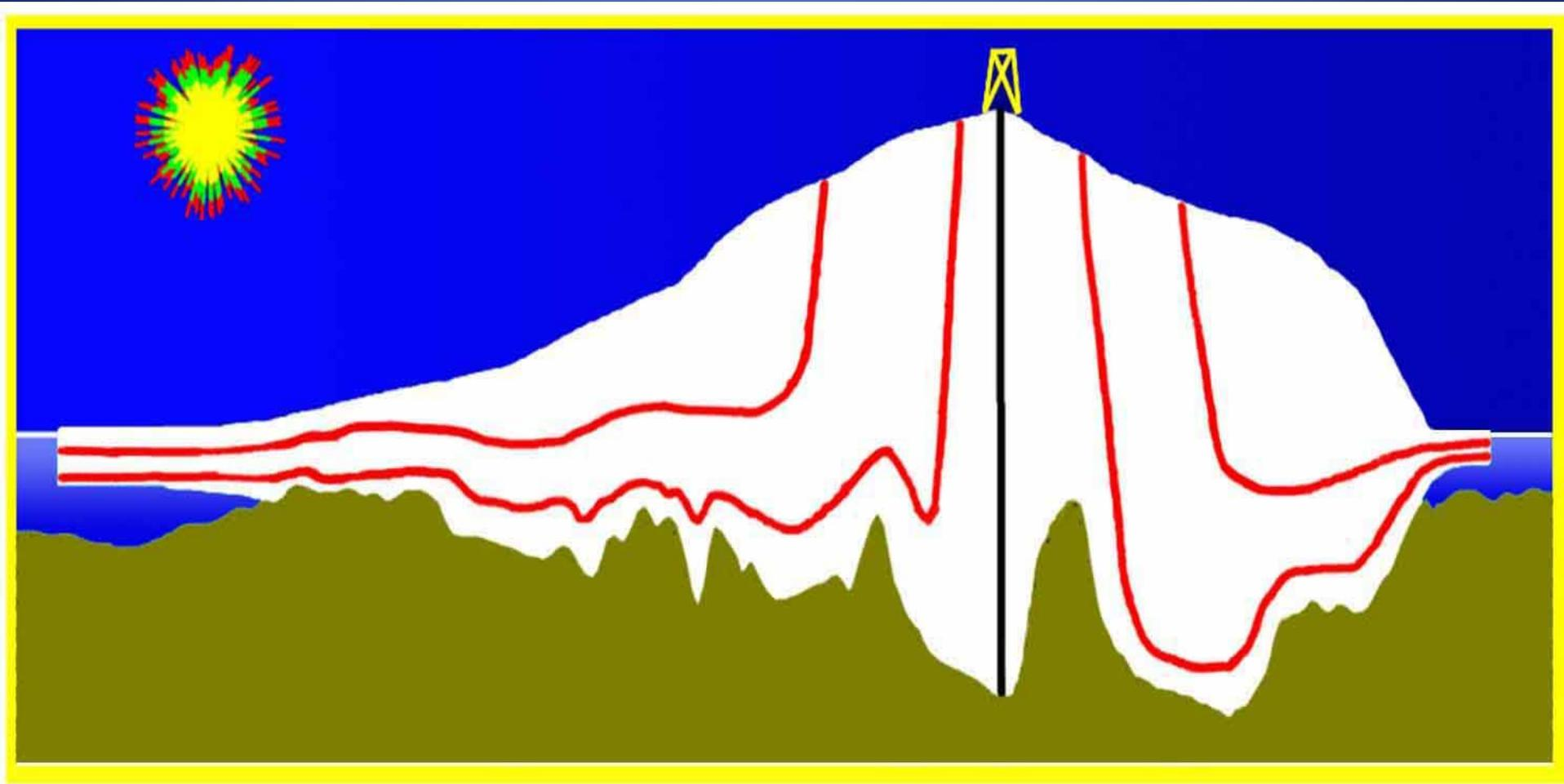

Engineer: Sure, but it took 4 seasons and \$\$ to get to that depth !

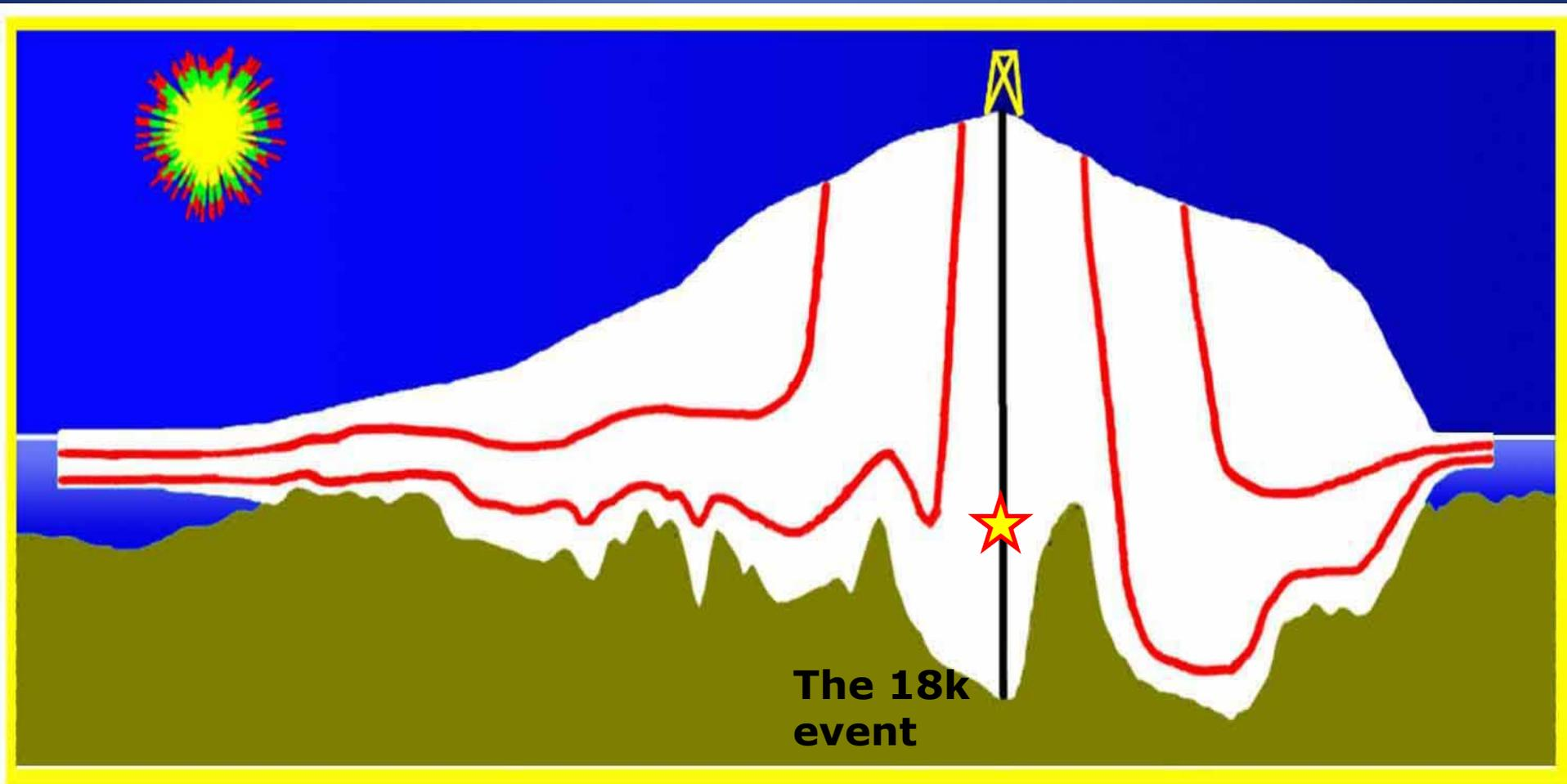

Engineer: What about drilling out the side of the hole instead?

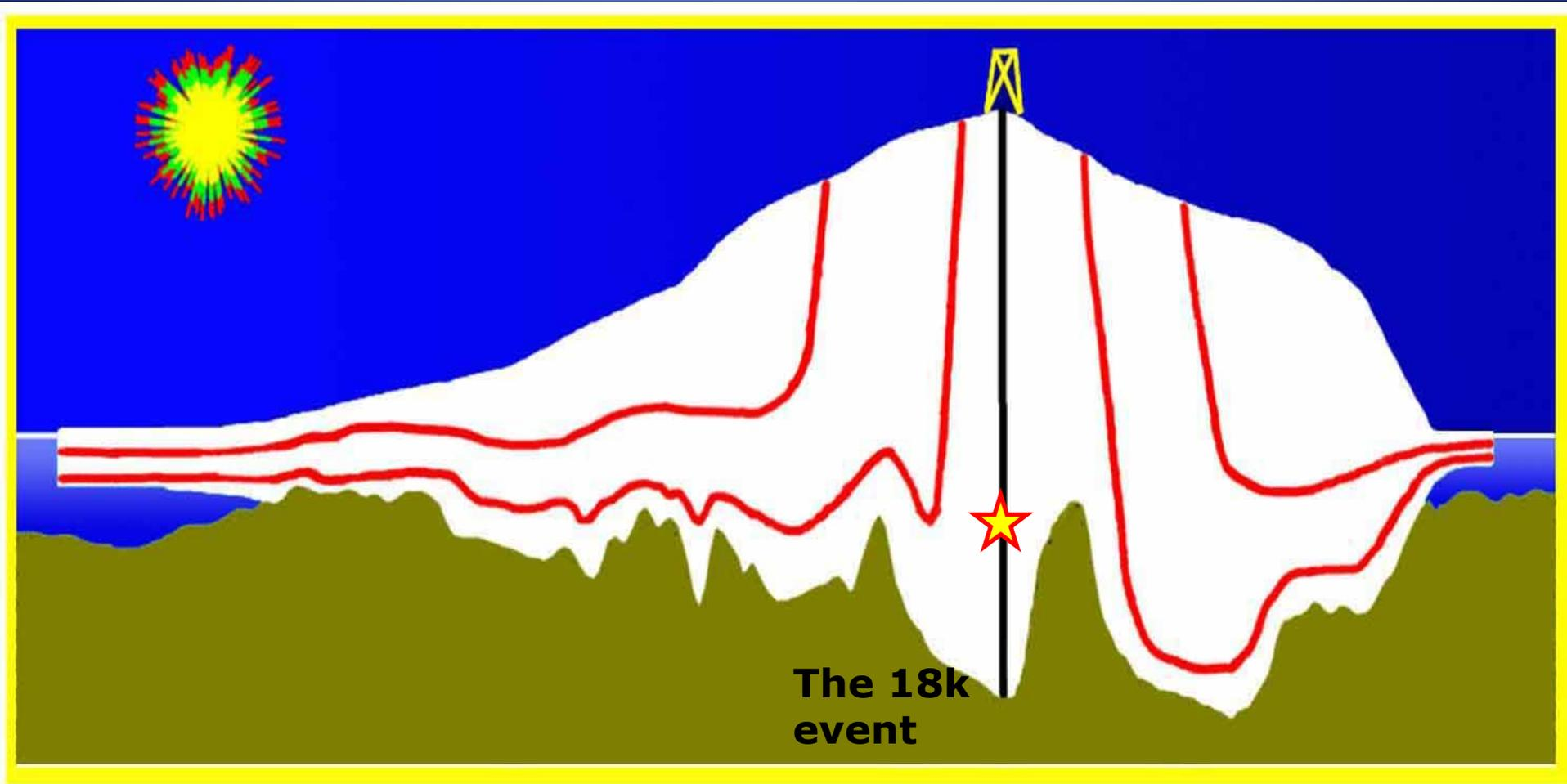

We can block the hole to deviate out the side. That's worked before-

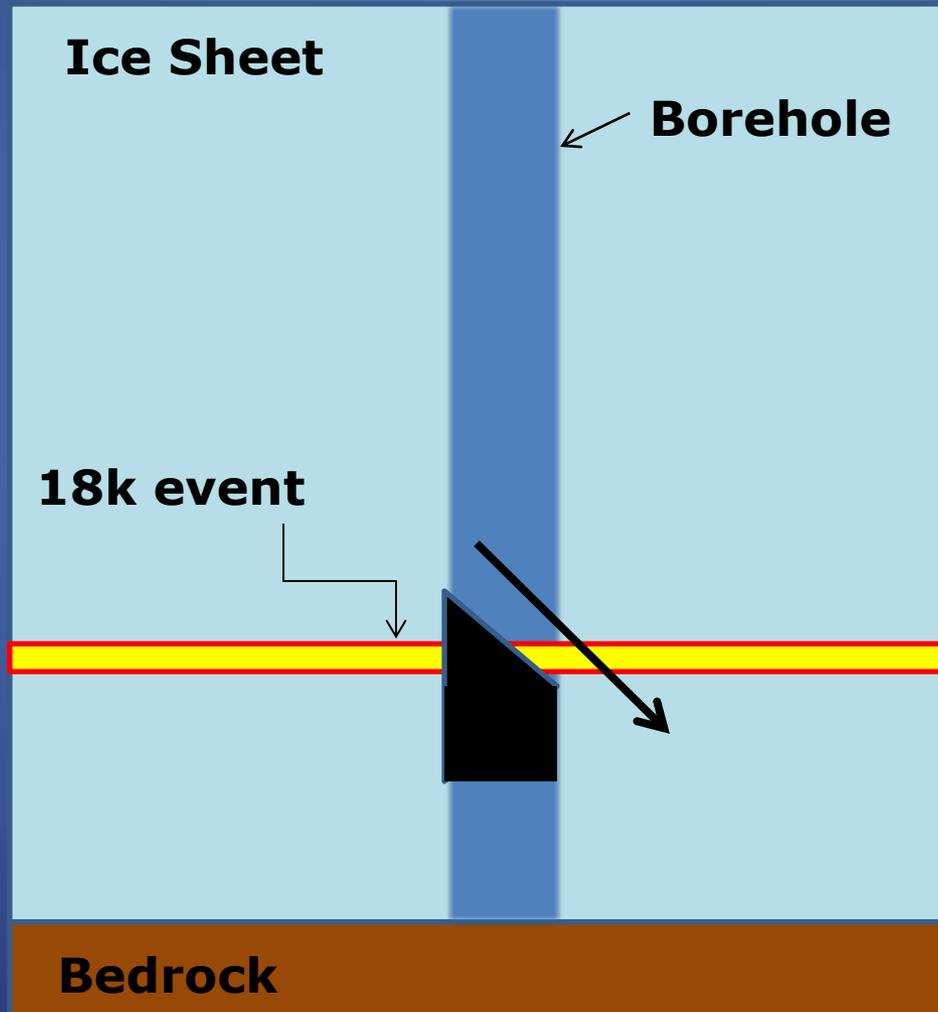

Scientist: No, I need to measure stuff down the entire borehole length

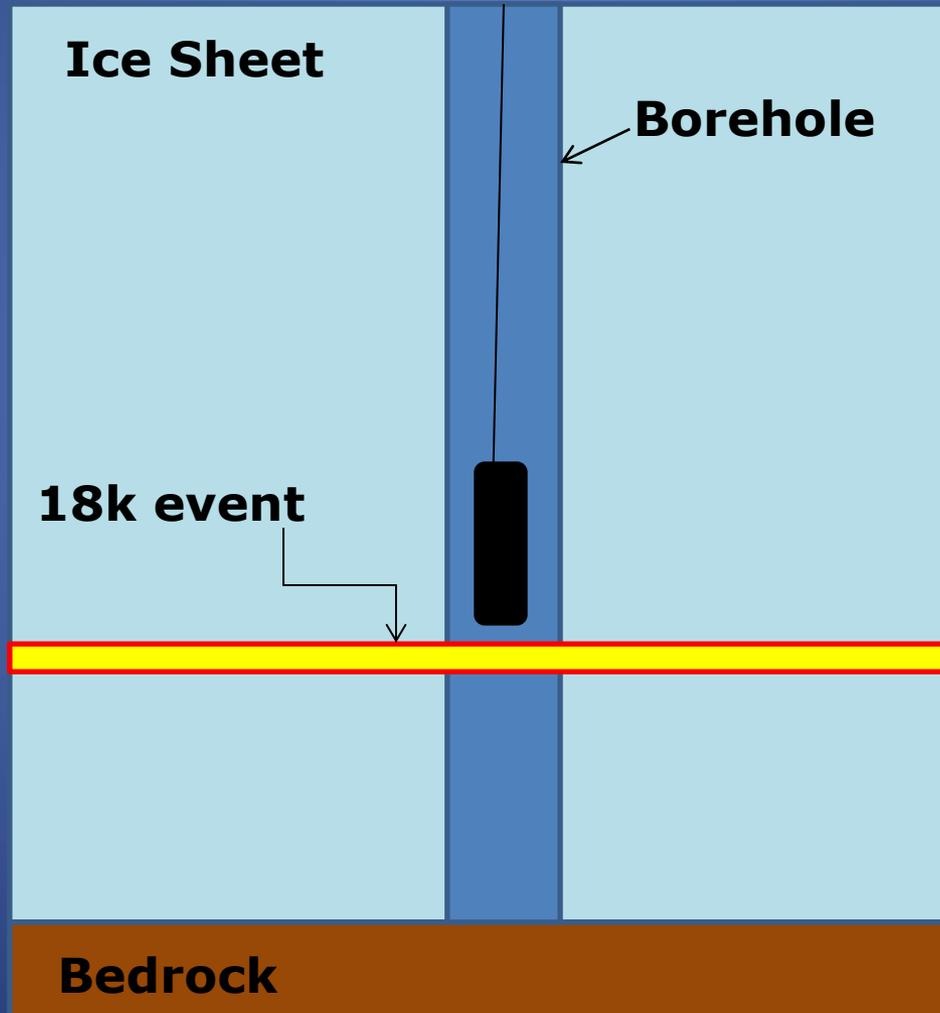

Instruments will need to get past the 18K event depth...

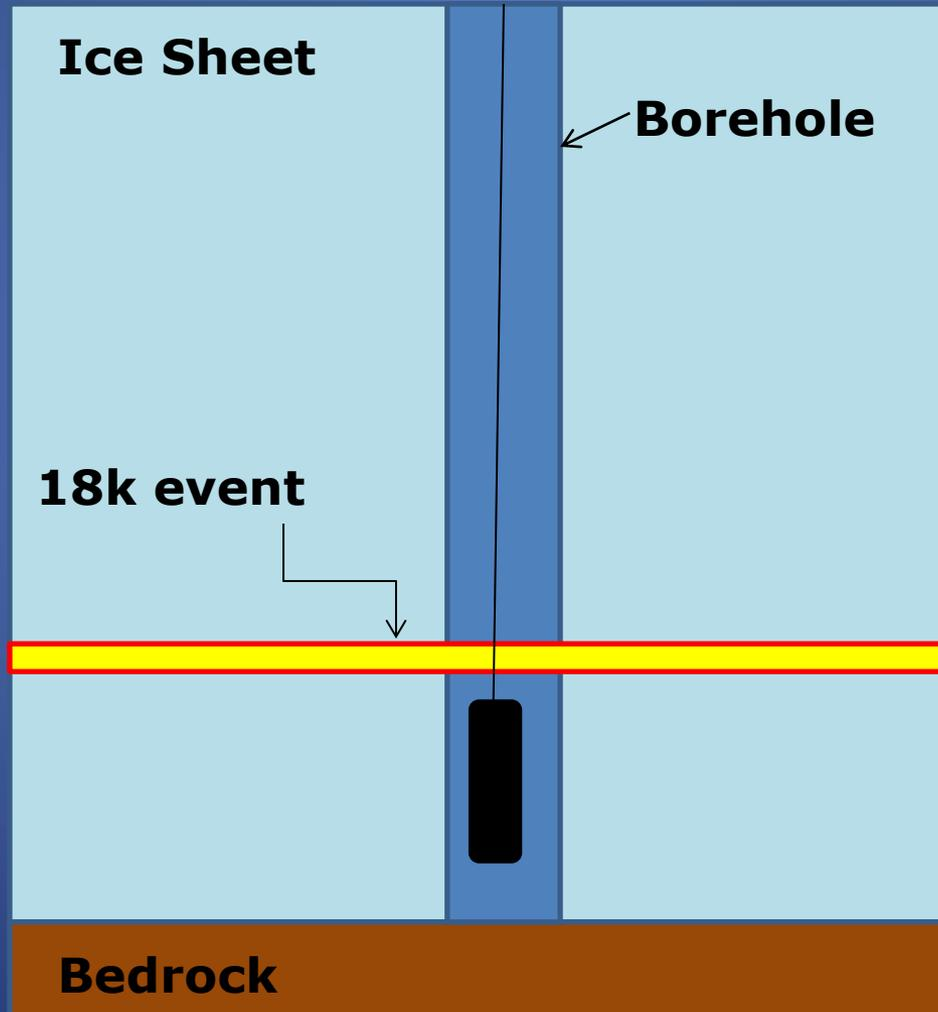

Sample Borehole "Logging" Tools

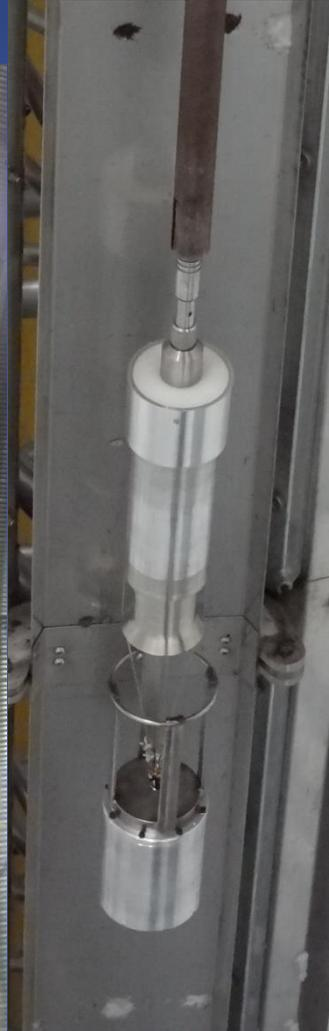

Optical

Seismic

**Sonic
Velocity**

Acoustic

Temperature

Engineer: So what about going out the uphill side of the borehole so gravity pulling the tools into deviations is not a factor?

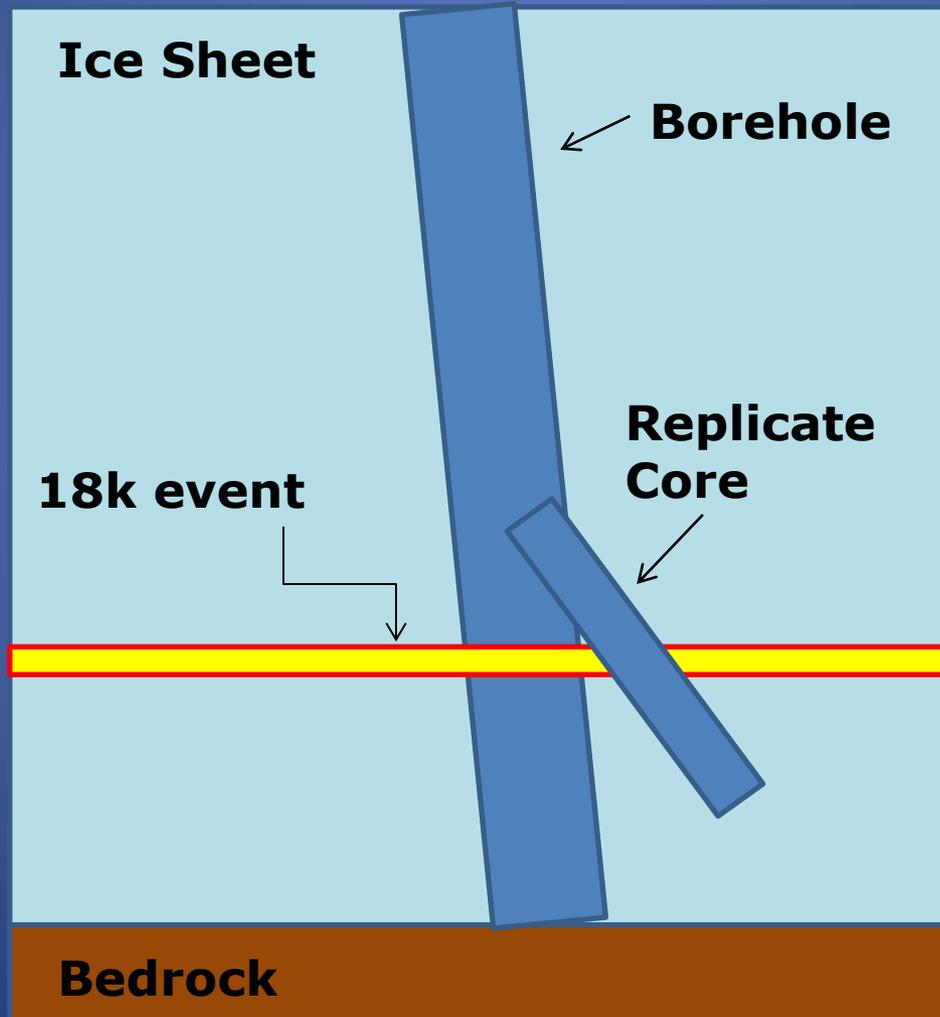

Tools with still pass by the replicate hole, - Yikes, this has never been done before!

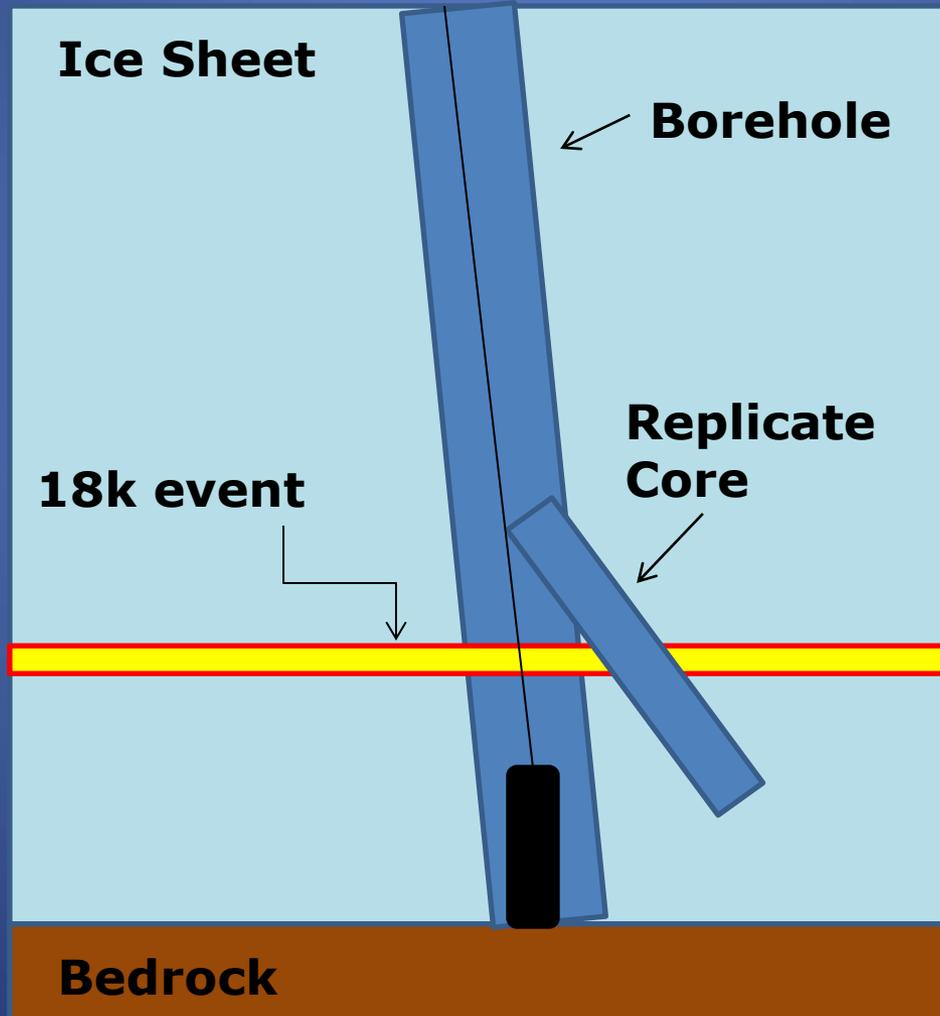

Science Goal: cores parallel to the main hole to duplicate results from depths of great interest-

Engineer: That's going to require a whole new kind of drill !!

Audience:

What kind of questions would you want to ask to define the drill the scientists need?

DISC Drill Modifications Done

Existing Components:

Pump/Motor Section

Instrument Section

Anti-torque Section

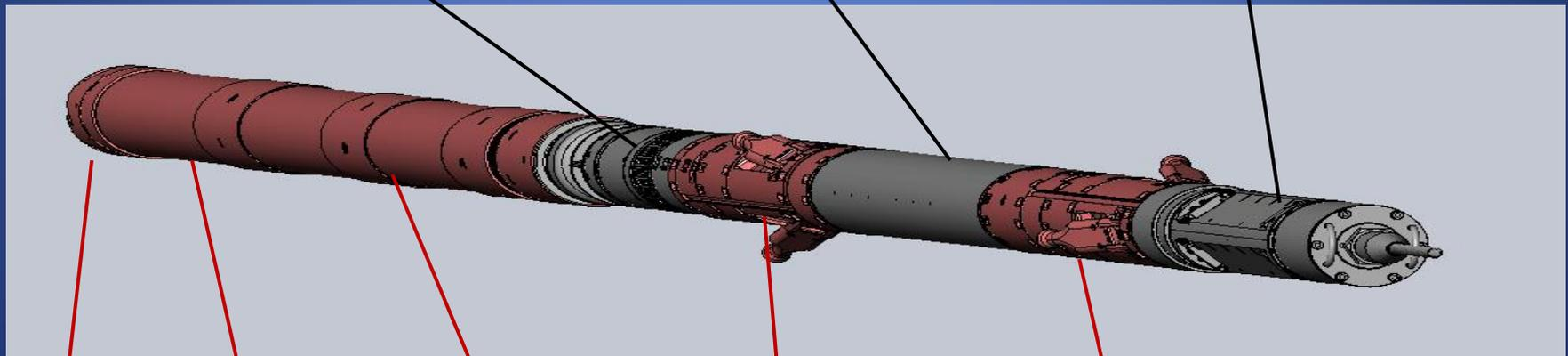

Cutter

Reduced
Diameter Core
Barrel

Reduced Diameter
Screen Barrels

Actuator Module

Actuator Module

New Components

Diagram Brainstorming Deviation

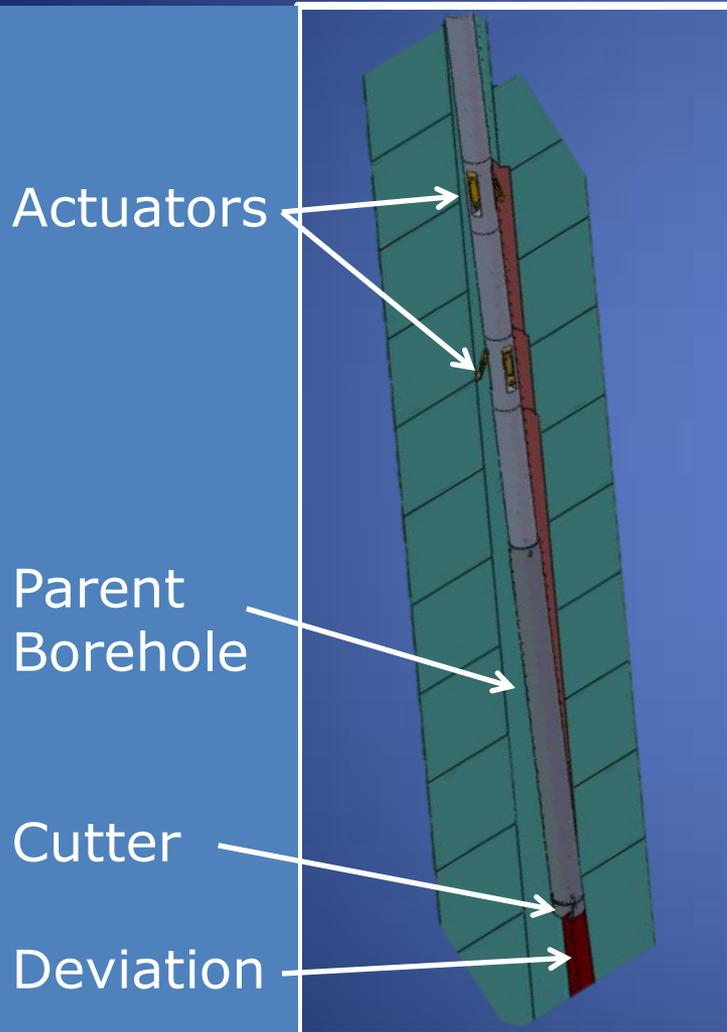

- Actuators Force Cutters to High-side of Parent Hole.
- Direction and Magnitude of Force via Surface Command
- Real-time Adjustments On-Board Controller
- Ascend/Descend to Deviate Over ~25m.

Prototype Testing Accomplished

Actuator

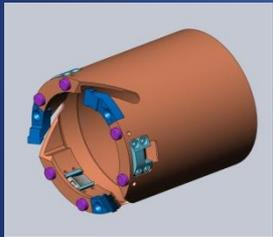

Coring Head



Milling Head

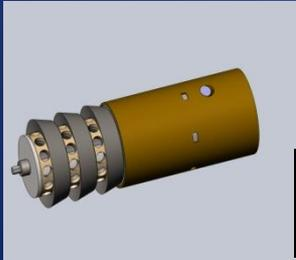

Broaching Head

Deviation Cutter



2011-12 Field Test: Problems identified



Summer 2012 - evaluation and redesign

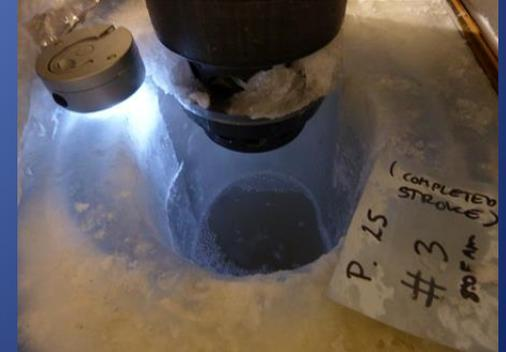

2012-13 season A Huge Success!

5 deviations were completed from at four different depths

- All goals were met
- 284m of core were recovered
- First time an ice borehole has been deviated on the high side!

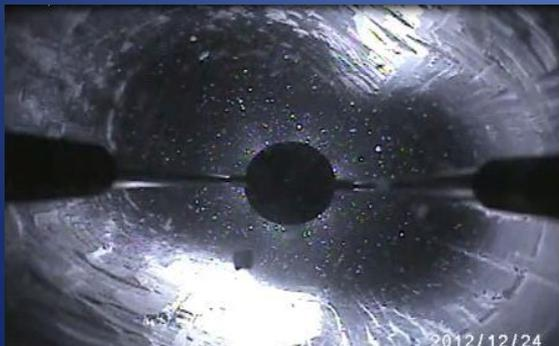

Morris for AGU 2013



The 18k event was recovered not once, but twice: Stay tuned for analysis of the event!

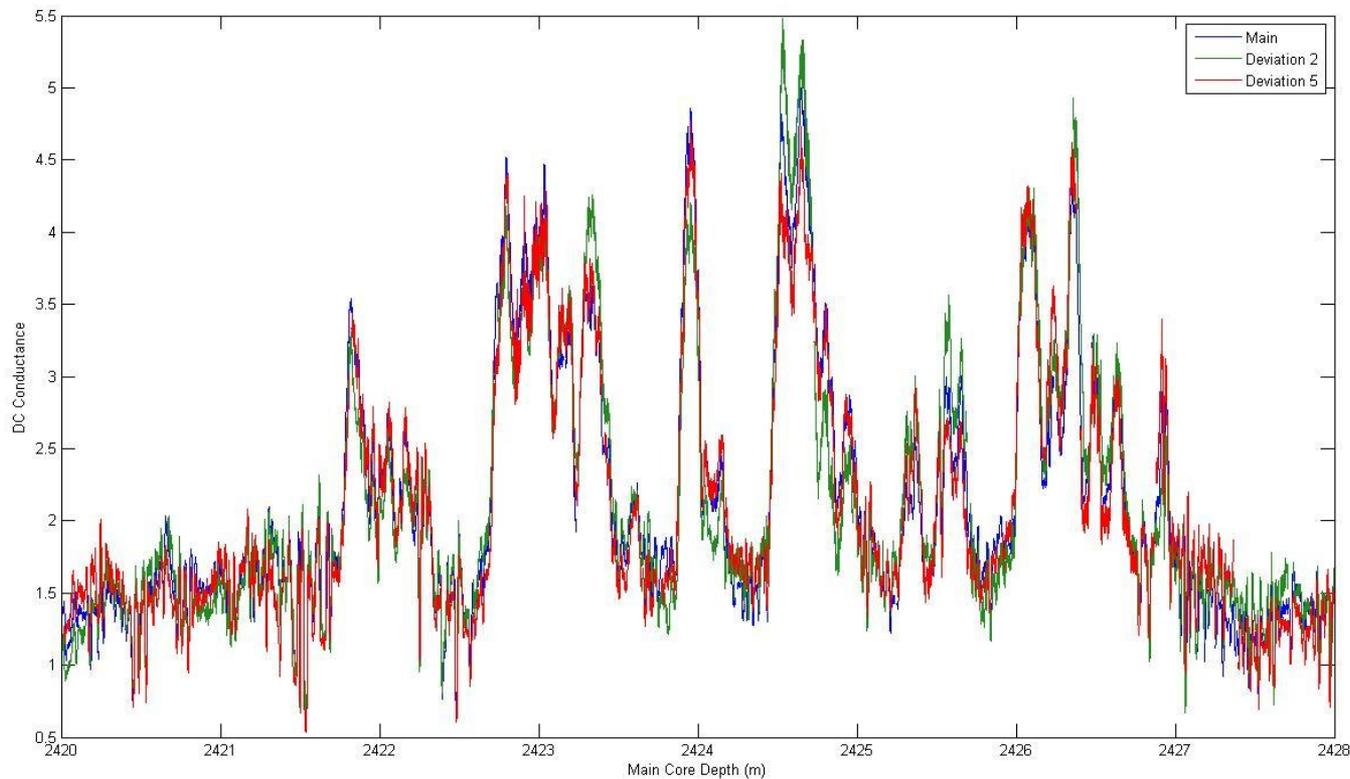

Audience Question:

**What processes or actions
did you observe the scientist
and/or engineer using?**

NGSS Practices-how'd we do?

- 1. Asking questions (for science) and defining problems (for engineering)**
- 2. Developing and using models**
- 3. Planning and carrying out investigations**
- 4. Analyzing and interpreting data**
- 5. Using mathematics and computational thinking**
- 6. Constructing explanations (for science) and designing solutions (for engineering)**
- 7. Engaging in argument from evidence**
- 8. Obtaining, evaluating, and communicating information**

Activity: Drilling Back Through Time

1) Prepare your students



2) View the movie

www.youtube.com/user/USIceDrillingVideos

3) Check off each step as you hear it modeled by a scientist or engineer

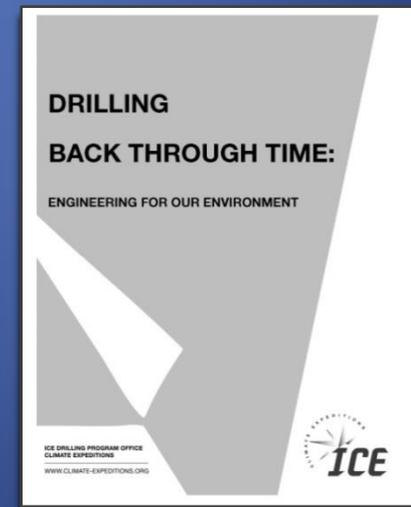

Resources

Activity:

- <http://www.climate-expeditions.org/educators/Drilling-Back-Through-Time.pdf>

US Ice Drilling Program

- www.icedrill.org
- www.climate-expeditions.org
- Linda.m.morris@dartmouth.edu

NSTA Webinar (will be archived)

- February 27, 2014:
Jihong Cole-Dai, Jay Johnson, Linda Morris
“Polar Science and Engineering”

